



Features

- Metal construction
- Includes installation hardware
- Complements the Memoirs Stately Suite

Colors/Finishes

- CP: Polished Chrome
- Other: Refer to Price Book for additional colors/finishes

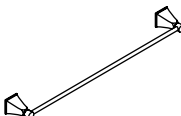
Specified Model

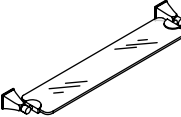
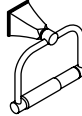
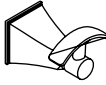
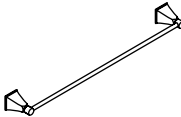
Model	Description		Colors/Finishes	
K-485	17" (43.2 cm) Towel bar		<input type="checkbox"/> CP	<input type="checkbox"/> Other _____
K-486	23" (58.4 cm) Towel bar		<input type="checkbox"/> CP	<input type="checkbox"/> Other _____
K-487	Towel ring		<input type="checkbox"/> CP	<input type="checkbox"/> Other _____
K-488	Glass shelf		<input type="checkbox"/> CP	<input type="checkbox"/> Other _____
K-490	Toilet tissue holder		<input type="checkbox"/> CP	<input type="checkbox"/> Other _____
K-492	Robe hook		<input type="checkbox"/> CP	<input type="checkbox"/> Other _____
K-494	18" (45.7 cm) Towel bar		<input type="checkbox"/> CP	<input type="checkbox"/> Other _____
K-495	24" (61 cm) Towel bar		<input type="checkbox"/> CP	<input type="checkbox"/> Other _____
K-497	30" (76.2 cm) Towel bar		<input type="checkbox"/> CP	<input type="checkbox"/> Other _____

Product Specification

The accessory shall be of metal construction. Accessory shall include installation hardware. Accessory shall complement the Memoirs Classic Suite. Accessory shall be Kohler Model K-_____-_____.

MEMOIRS® STATELY

Installation Notes

Install all products according to the installation guide.

Measure the length of the bonnet included with your accessory to determine the correct roughing-in dimensions, noted "[A]" or "[B]" in the product diagram.

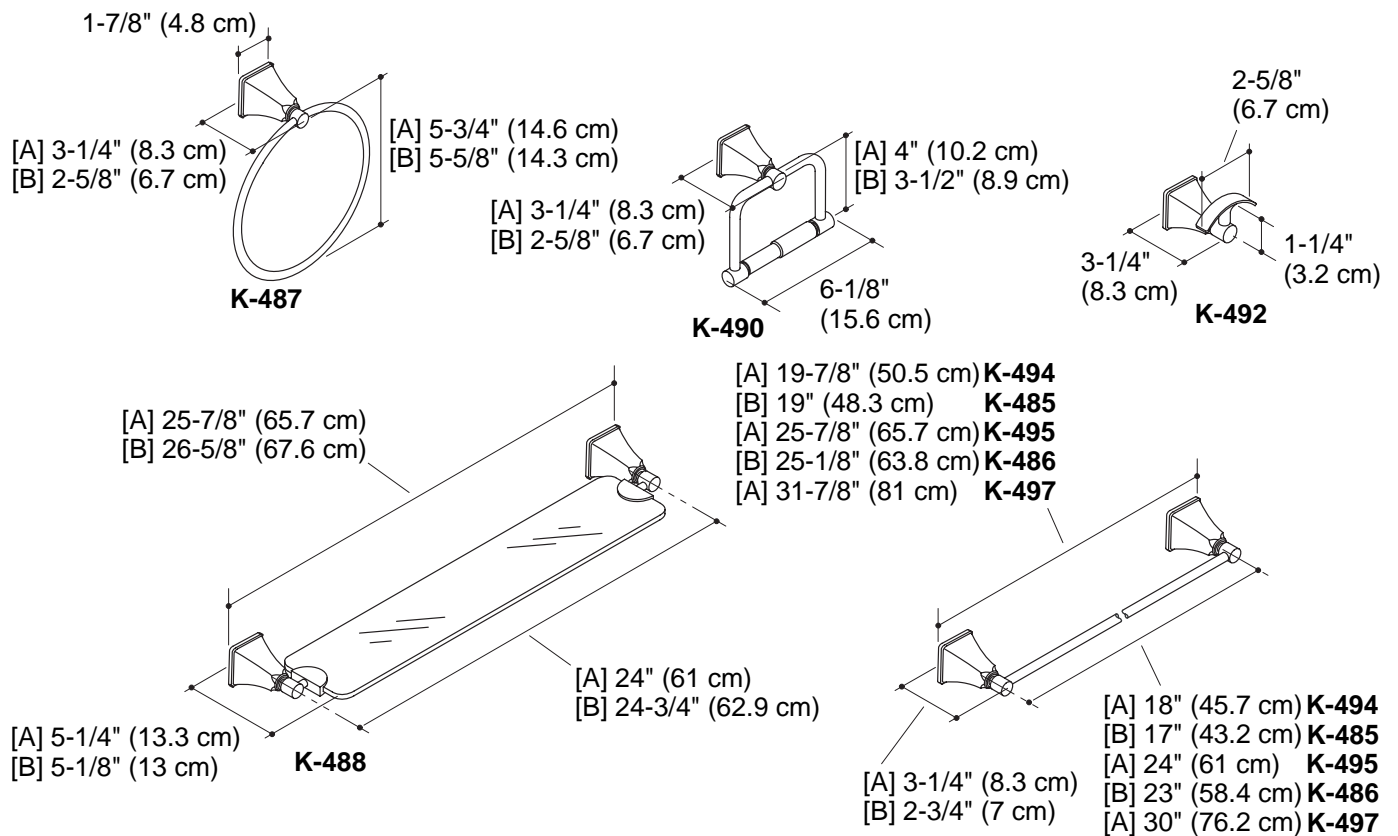

Product Diagram